

# Sales Proposal



*"Catch the Fitness Wave!"*

LLOYD's Exercise Equipment, L.L.C.  
 PO Box 290723  
 Port Orange, FL 32129  
 386-322-3213 (office) / 815-331-5329 (fax)  
 info@lloydsfitness.com

Date	Estimate #
11/16/2021	10925-2

**Customer**

Bayshore Bath and Tennis Club  
 925 N. Halifax Avenue  
 Daytona Beach, FL 32118  
 386-255-3686 (Bob)  
 917-656-8869 (Joe)

P.O. No.	Bidding Info
Pending	n/a

Manufacturer	Item	Model/Notes	Details	Amount
	Delivery & Assembly		Free	0.00
	Removal	* Strength Equipment Removal As A Courtesy.		0.00
	Miscellaneous	Move Treadmill from one room to another room.	(no charge)	0.00

Approval Date: \_\_\_\_\_  
 Name: \_\_\_\_\_  
 Title: \_\_\_\_\_

<b>Subtotal</b>	<b>\$20,739.00</b>
<b>Sales Tax (6.5%)</b>	<b>\$1,348.04</b>
<b>Estimate Total</b>	<b>\$22,087.04</b>

*"Specializing in Service After the Sale"*  
 \* 24986.04

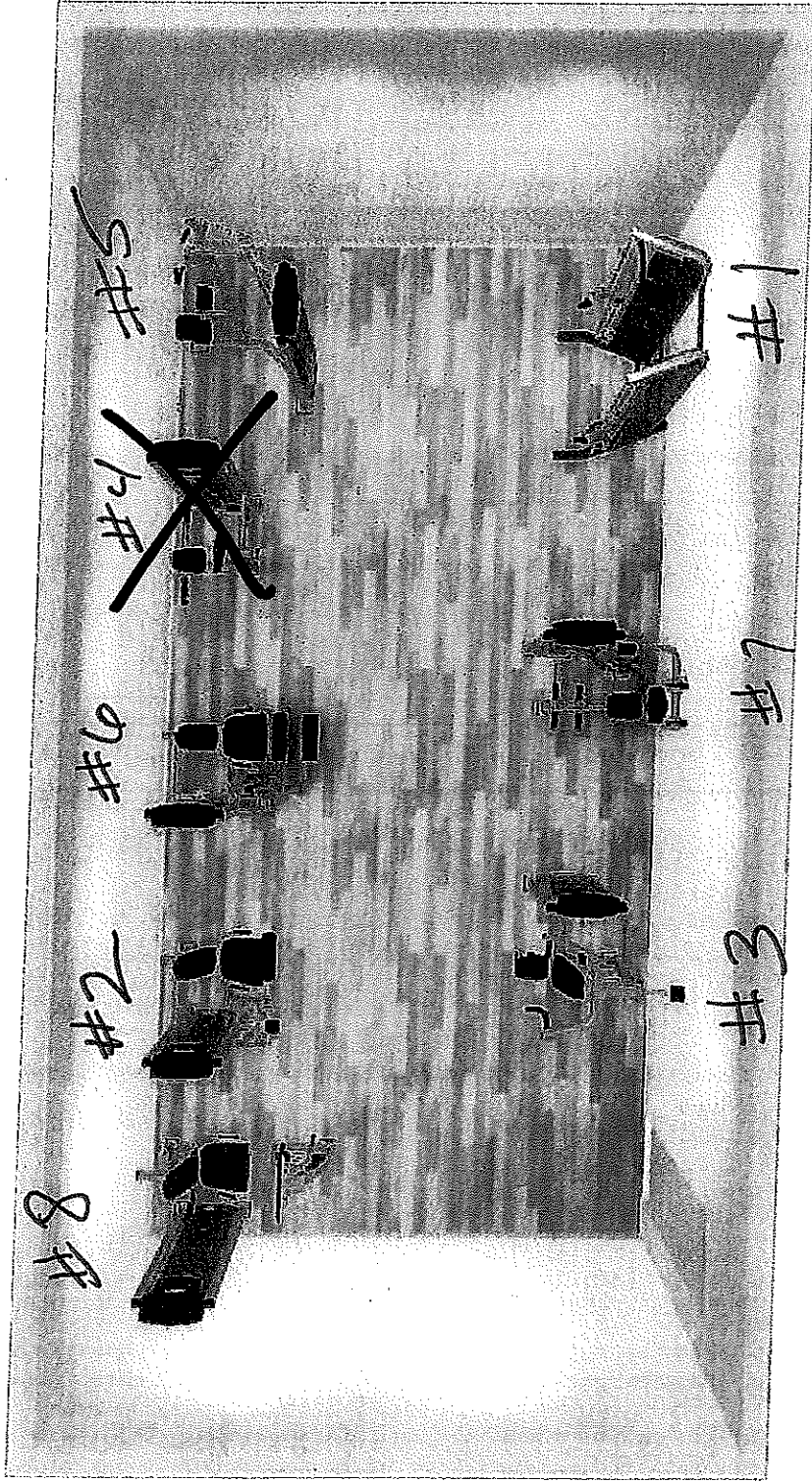

# Sales Proposal

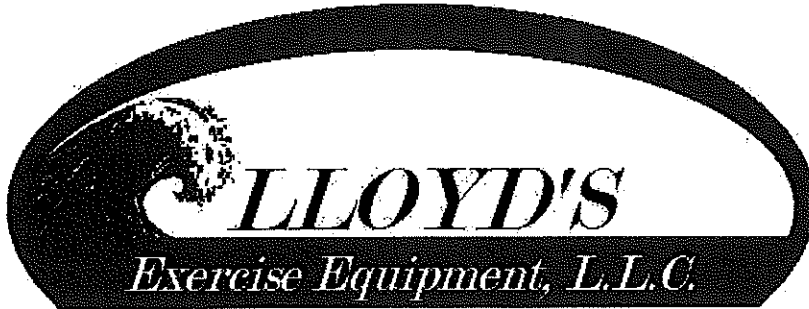

*"Catch the Fitness Wave!"*

LLOYD's Exercise Equipment, L.L.C.  
 PO Box 290723  
 Port Orange, FL 32129  
 386-322-3213 (office) / 815-331-5329 (fax)  
 info@lloydsfitness.com

Date	Estimate #
11/16/2021	10925-2

**Customer**

Bayshore Bath and Tennis Club  
 925 N. Halifax Avenue  
 Daytona Beach, FL 32118  
 386-255-3686 (Bob)  
 917-656-8869 (Joe)

P.O. No.	Bidding Info
Pending	n/a

Manufacturer	Item	Model/Notes	Details	Amount
Batca #1	Functional Trainer	Axis - LFT Retail \$5995.00	1 at \$4395.00	4,395.00
Batca #5	Circuit Machines	LD-2 Lat / Row Retail \$3395.00	1 at \$2699.00	2,699.00
Batca #6	Circuit Machines	LD-3 Leg Press / Calf Raise Retail \$3695.00	1 at \$2849.00	2,849.00
Batca #7	Circuit Machines	LD-4 Leg Extension / Curl Retail \$3495.00	1 at \$2749.00	2,749.00
Batca #3	Circuit Machines	LD-1 Multi Press / Fly Retail \$3695.00	1 at \$2849.00	2,849.00
Batca #2	Circuit Machines	LD-7 Bicep / Tricep Retail \$3095.00	1 at \$2549.00	2,549.00
Batca #8	Circuit Machines	LD-5 Back / AB Retail \$3195.00	1 at \$2649.00	2,649.00

Approval Date: \_\_\_\_\_  
 Name: \_\_\_\_\_  
 Title: \_\_\_\_\_

<b>Subtotal</b>
<b>Sales Tax (6.5%)</b>
<b>Estimate Total</b>



**BATCA**  
FITNESS SYSTEMS USA

# 2

**LINEA**  
DUAL FUNCTION

# LD-7

SELF-ADJUSTING ARM

ADJUSTABLE CHEST PAD

GAS ASSISTED SEAT

STARTING POINT ADJUSTMENTS

COUNTER-BALANCED

EXERCISE ARM

150 LB. WEIGHT STACK

EXERCISE DEMO VIA  
INTEGRATED QR CODE

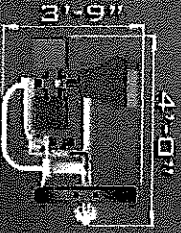
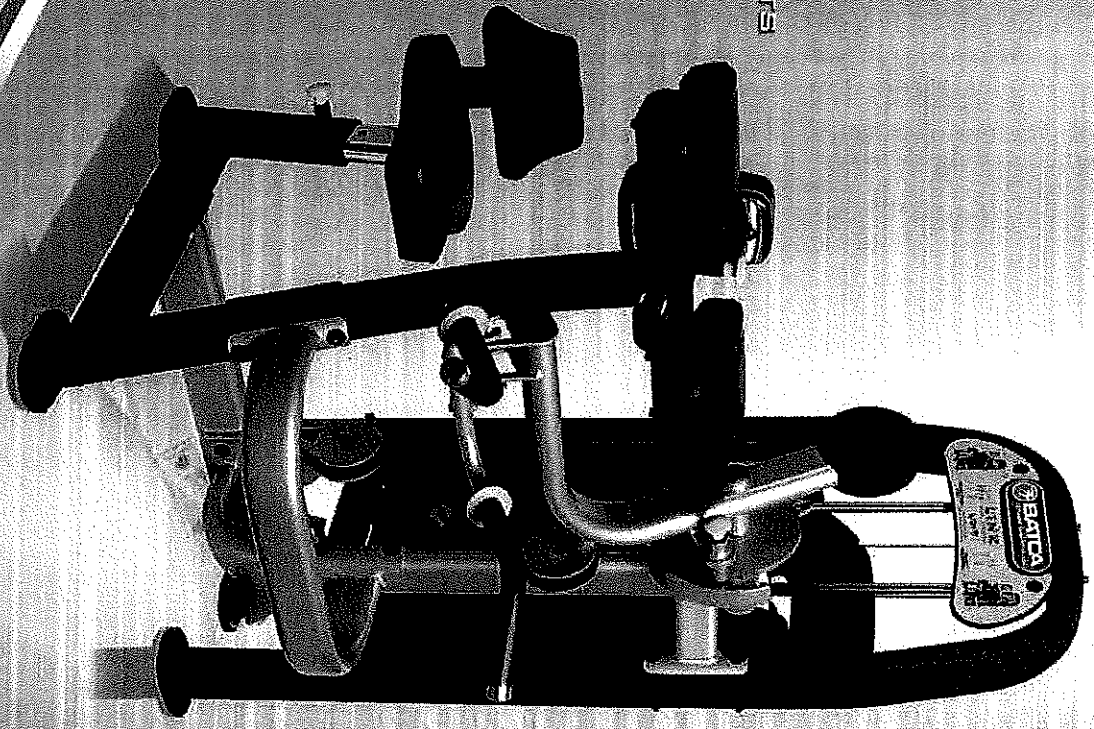

HEIGHT: 5'-0"  
WEIGHT: 426 LBS

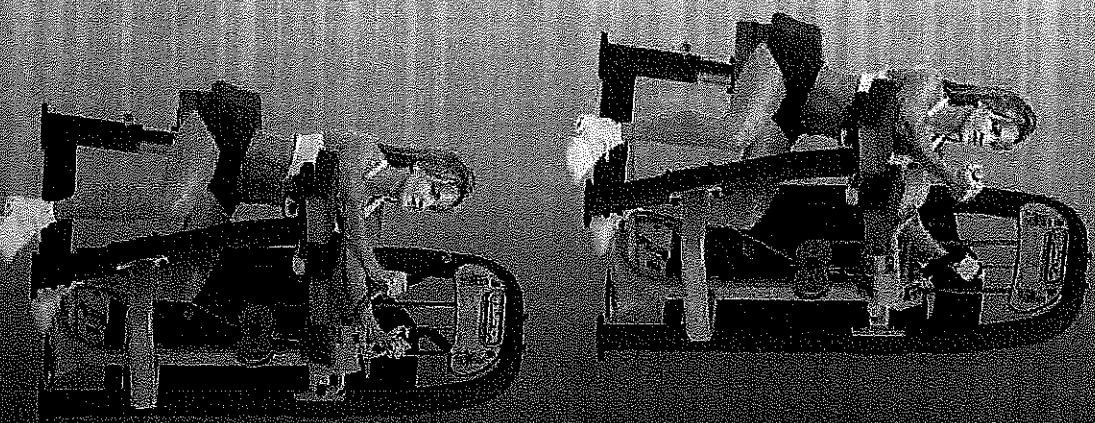

**LD-7 SEATED BICEP CURL/TRICEP EXTENSION**



**BATEA**  
Fitness Systems USA

**LD-1**

CHEST PRESS FOOT ASSIST

DUAL HANDGRIPS

GAS ASSISTED SEAT

SELF-ADJUSTING PEG  
FLY ARMS

PEG FLY RANGE OF MOTION

1.25 TO 1 CHEST PRESS  
WEIGHT RATIO

(250 LBS. ACTUAL RESISTANCE)

200 LB. WEIGHT STACK

EXERCISE DEMO VIA  
INTEGRATED QR CODE

#3

**LINK**  
DUAL FUNCTION

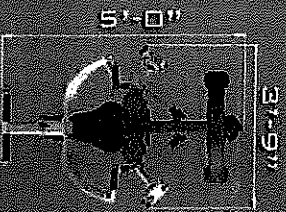
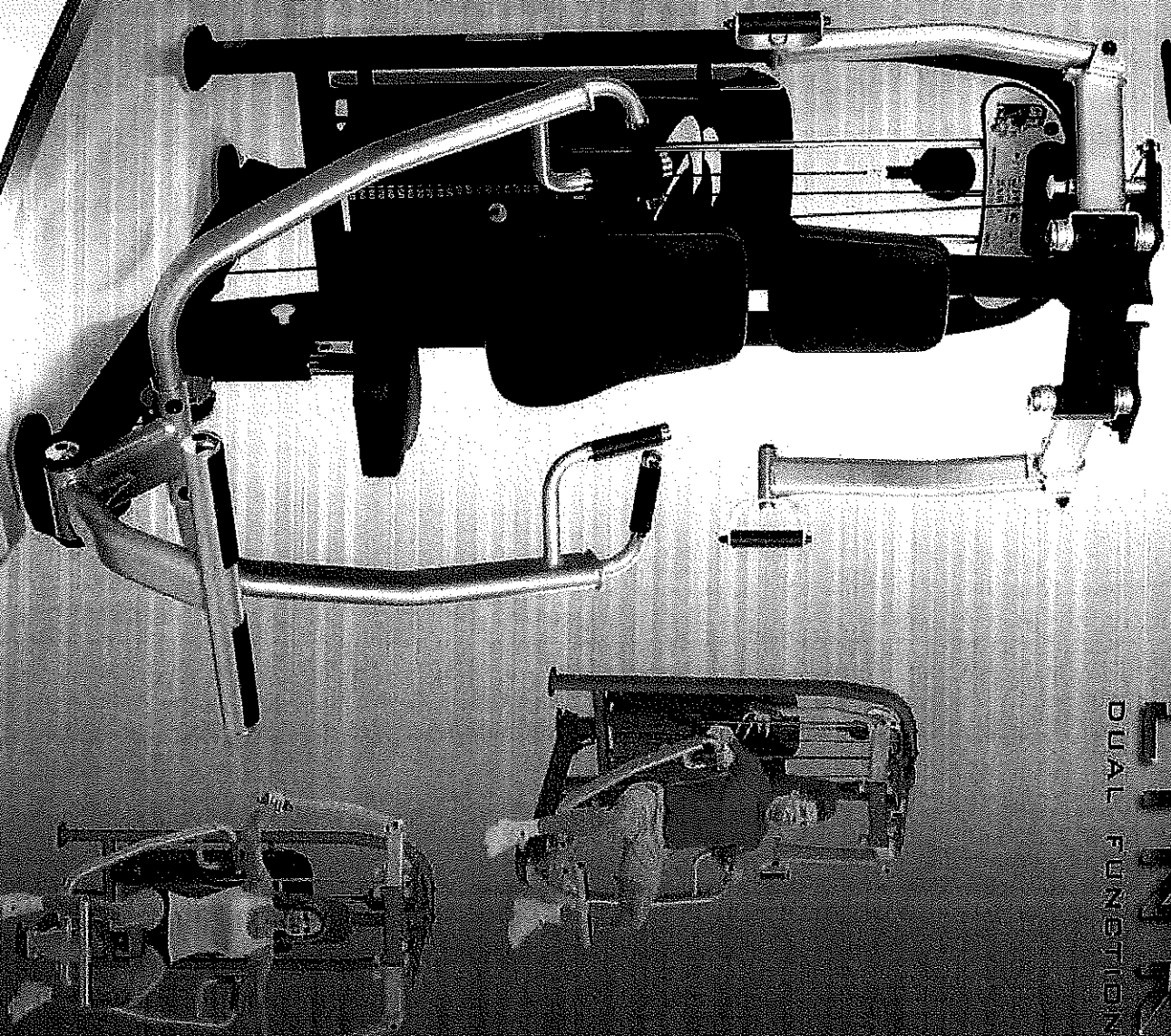

HEIGHT: 5'10"  
WEIGHT: 553 LBS



**LD-1 CHEST PRESS/PEG FLY**

**LINK**  
DUAL FUNCTION

#5



**BATCA**  
FITNESS SYSTEMS USA

**LD2**

TELESCOPING CHEST PAD

DUAL HANDGRIPS

GAS ASSISTED SEAT

HOLD-DOWN ROLLERS

SWIVELING HIGH PULLEY

200 LB. WEIGHT STACK

EXERCISE DEMO VIA  
INTEGRATED QR CODE

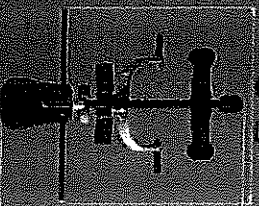

31-8"

51-1"

HEIGHT: 71-0"  
WEIGHT: 505 LBS

LD-2 MID ROW/LAT PULL DOWN

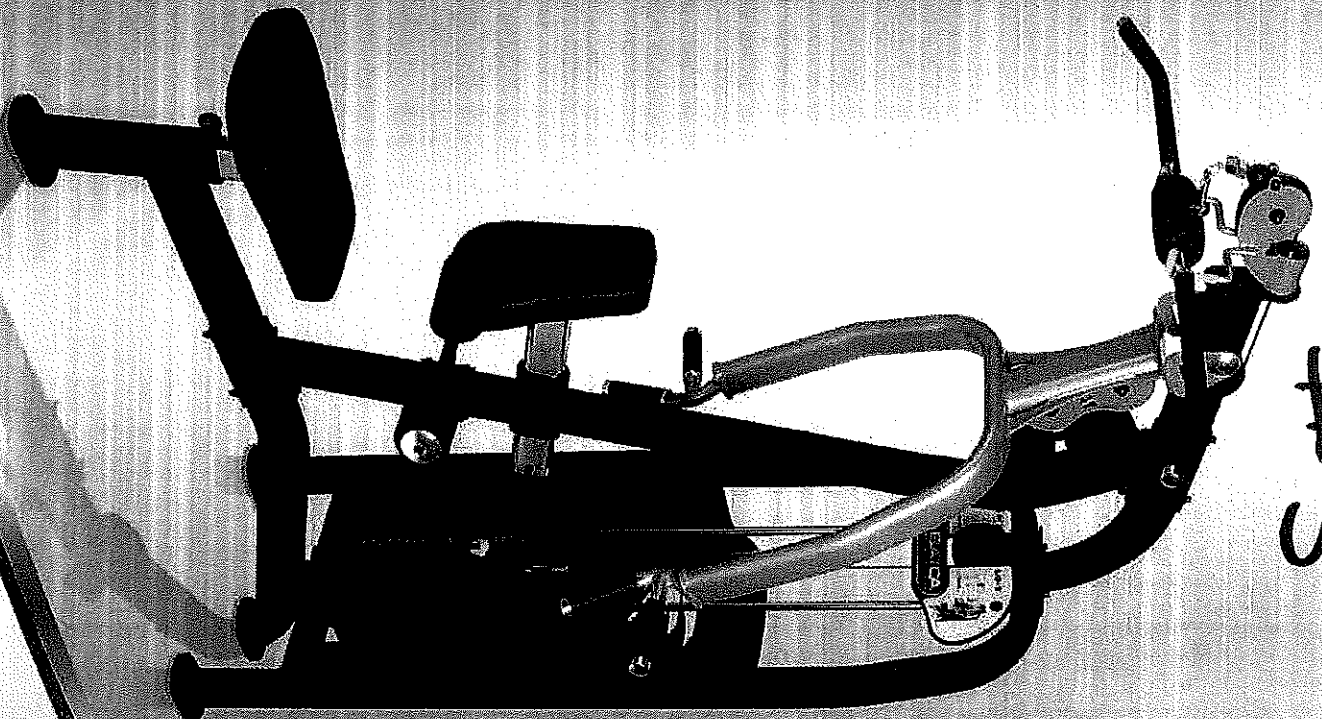



**BATCA**  
FITNESS SYSTEMS USA

**LD3**

#6

**LINK**  
DUAL FUNCTION

WALK THROUGH FRAME DESIGN

TELESCOPING BACK PAD

LARGE FOOTPLATE

DUAL FOUR BAR LINKAGE

2 TO 1 WEIGHT RATIO

(400 LBS. ACTUAL RESISTANCE)

200 LB. WEIGHT STACK

EXERCISE DEMO VIA  
INTEGRATED QR CODE

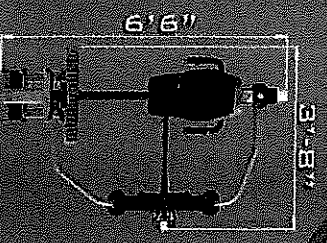
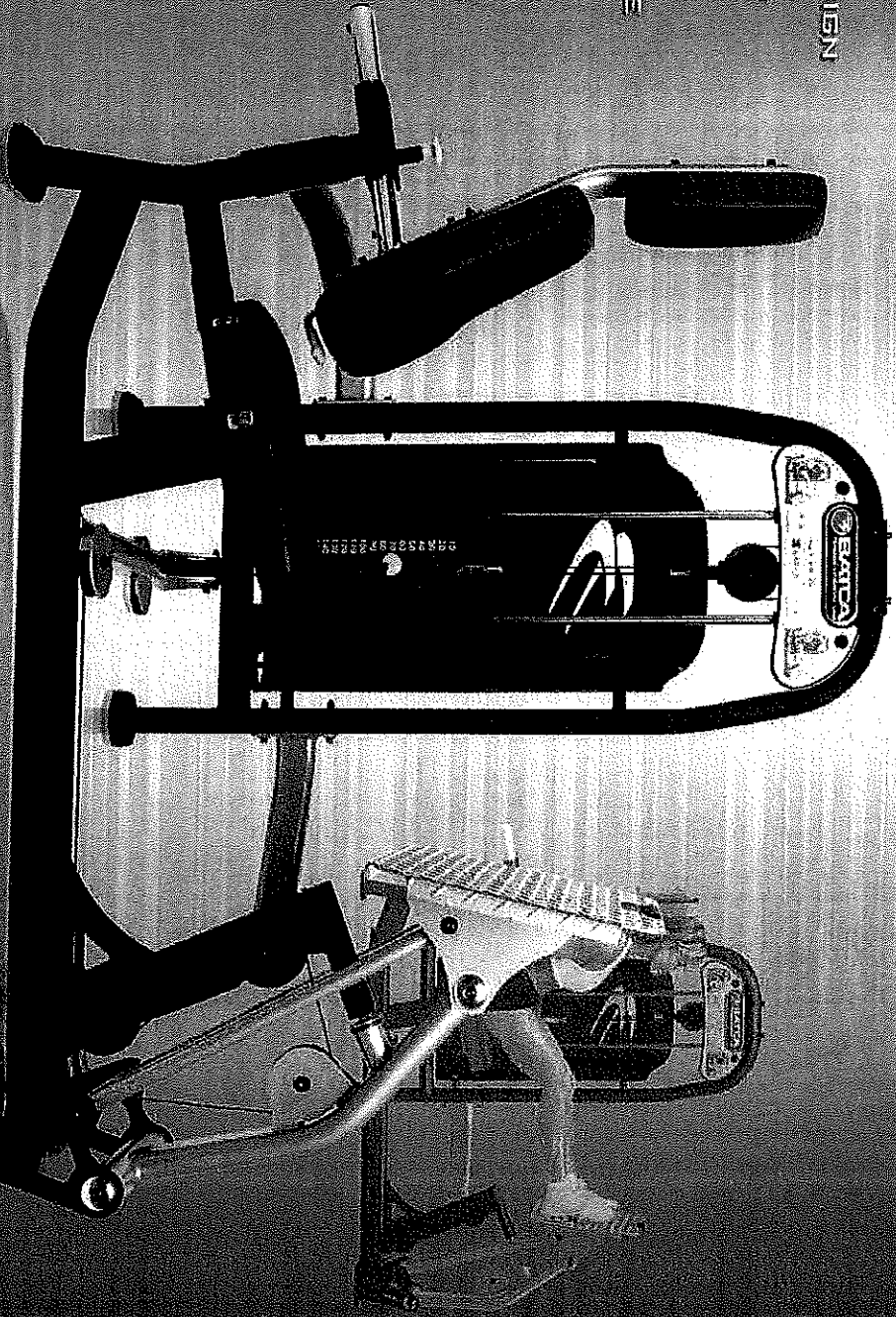

HEIGHT: 5'10"  
WEIGHT: 619 LBS



**LD-2 LEG PRESS/GALF RAISE**

**LINK**  
DUAL FUNCTIONION

#7



**BATA**  
FITNESS SYSTEMS, USA

**LD 4**

PATENTED KNEE  
ALIGNMENT SUPPORT

LEG CURL  
HOLD-DOWN ROLLERS

TELESCOPING BACK PAD

RANGE OF  
MOTION SETTINGS

COUNTER-BALANCED  
EXERCISE ARM

200 LB. WEIGHT STACK

EXERCISE DEMO VIA  
INTEGRATED QR CODE

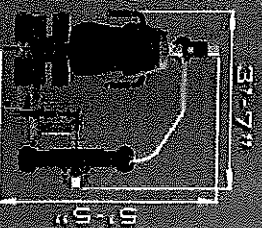
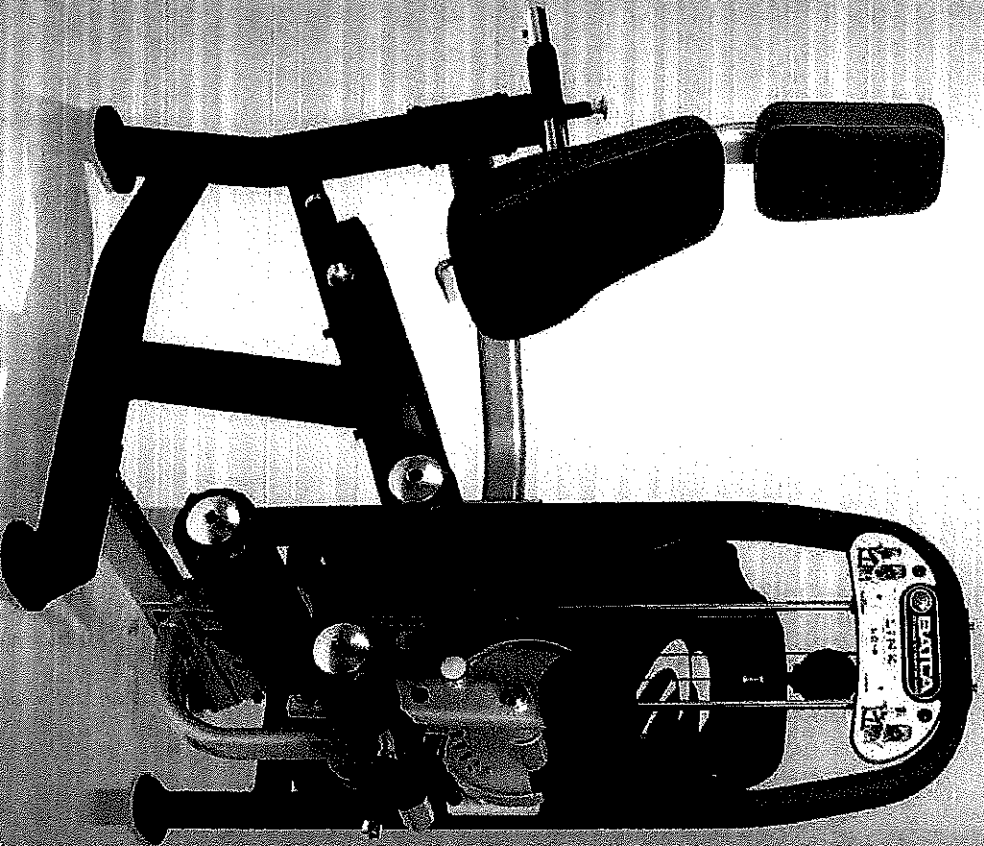

HEIGHT: 31.0"  
WEIGHT: 529 LBS

LD-4 LEG EXTENSION/SEATED LEG CURL







**BATECA**  
FITNESS SYSTEMS USA

#8

**LD 5**

**LINKER**  
DUAL FUNCTION

RANGE OF MOTION SETTINGS

LARGE CHEST/BACK  
ROLLER PAD

ADJUSTABLE FOOT PLATFORM

COUNTER-BALANCED  
EXERCISE ARM

BACK EXTENSION HANDLES

150 LB. WEIGHT STACK

EXERCISE DEMO VIA  
INTEGRATED QR CODE

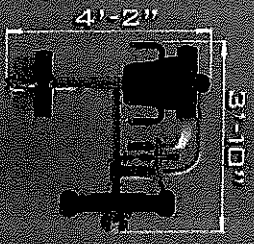
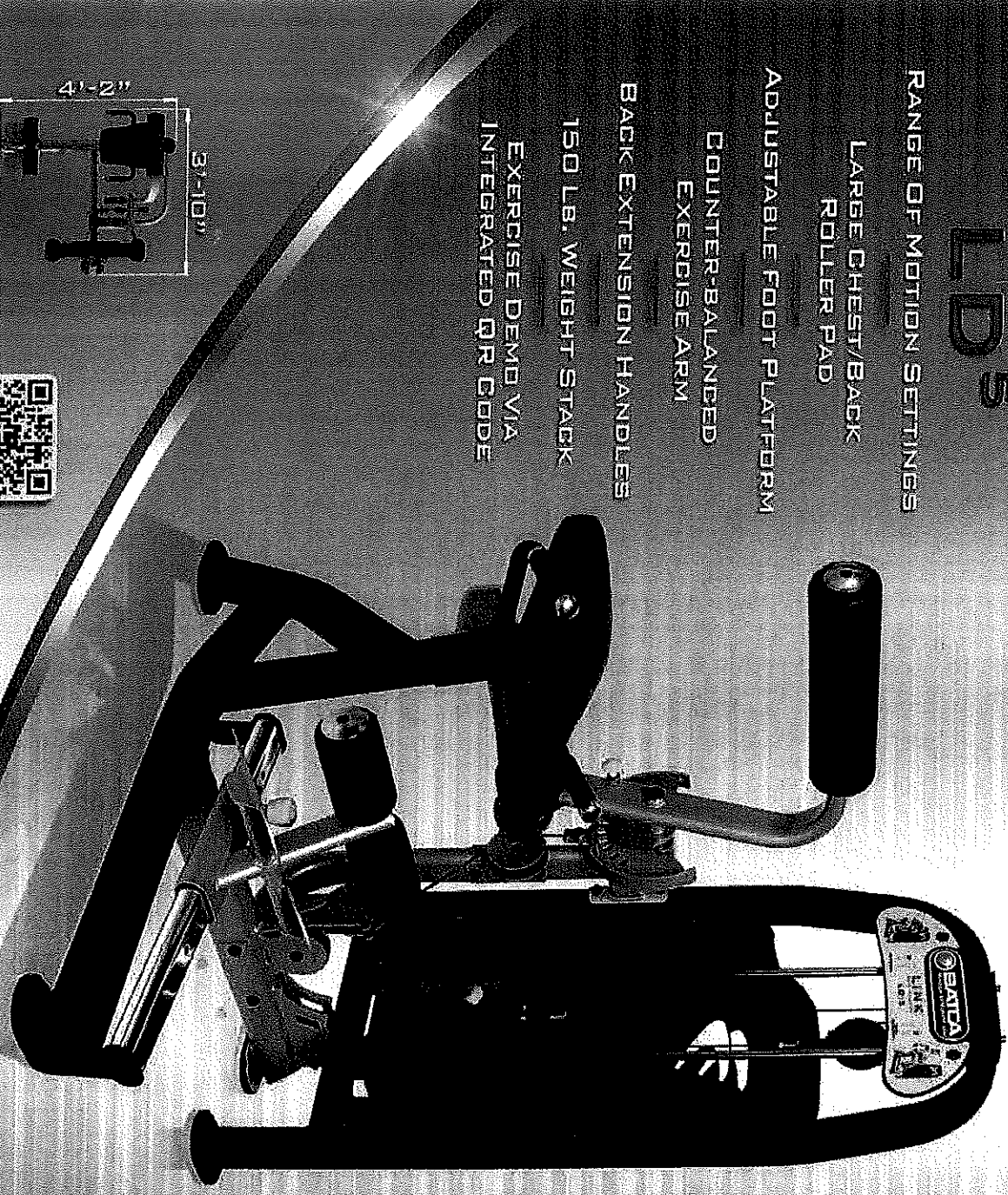

HEIGHT: 5'-0"  
WEIGHT: 430 LBS



**LD-5 AB CRUNCH/BACK EXTENSION**

**LINK**  
DUAL FUNCTION

# 4



**BATCA**  
FITNESS SYSTEMS, USA

**LD-8**

WEIGHT STACK SHROUD  
PROVIDES PRIVACY

DUAL FOOT RESTS

CONToured BACK PAD

360-DEGREE  
ROTATING KNEEPADS

RANGE OF MOTION SETTINGS

150 LB. WEIGHT STACK

EXERCISE DEMO VIA  
INTEGRATED QR CODE



HEIGHT: 5'-0"  
WEIGHT: 464 LBS

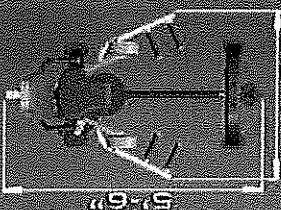

LD-8 INNER/OUTER THIGH

